

# CityVu/EdgeVu M-Series Swing Door (M600/M605)

## Technical Data Sheet

### Frame/Sash

- Architectural Grade 6063-T63 Aluminum
- Azon Thermal Break (Mainframe/Sash)
- 45 Degree Mitered Mainframe/Sash Corners
- Corner Key Technology
- Silicone Injected Corner Keys
- 4-1/2" Overall Frame Depth
- 4" Stiles and Rails
- Single/French and Sidelite Door Options

### Glazing

- Exterior & interior Glazing Stop Options
- Quanex Super Spacer
- 100% Silicone Wet Glaze
- Double Pane Insulated Glass Options
- Annealed, Tempered, Laminated and Obscure Glass Options Available

### Weather Stripping

- Dual Bulb Gaskets

### Hardware

- Adjustable Butt Hinges
- Multi-Point Lock System

### Mulling Options

- Field Applied Structural Mulls

### Grid Options

- Grids Between the Glass
- Simulated Divided Lites
- True Divided Lites

### Sill Options

- Standard/Low Profile/ADA

### Paint

- 2604/2605 FGIA High Performance Powder Coatings
- 30 Standard Colors
- Custom Colors available

CityVu/EdgeVu M-Series Swing Door (M600/M605)		
NAFS Rating	LC-PG50	
Design Pressure (P.S.F.)	90	
Air Infiltration at 25 MPH (cfm/ft <sup>2</sup> )	0.09	
Water Resistance	7.52	
U-Value (Based on Cardinal 366 Low-E/Argon Fill)	0.39	
SHGC (Based on Cardinal 366 Low-E/Argon Fill)	0.22	
<b>Frame Sizing</b>	<b>Width</b>	<b>Height</b>
Minimum	24"	77"
Maximum	48"	120"



Quaker Window Products  
 504 U.S. Hwy 63 South  
 Freeburg, MO 65035  
 (800) 347-0438  
[www.quakerresidentialwindows.com](http://www.quakerresidentialwindows.com)

Discover More Here:



QTZ-CV/EV-M-SWNG-0324

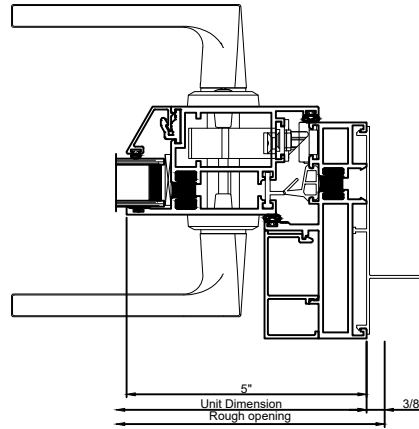
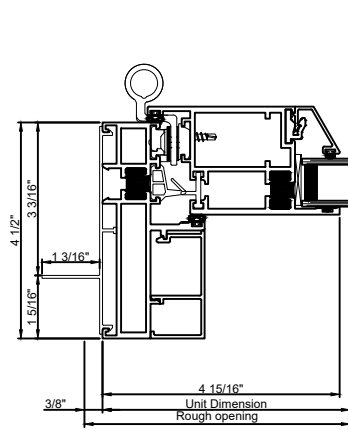

Door cut sections 1 : 4

Exterior

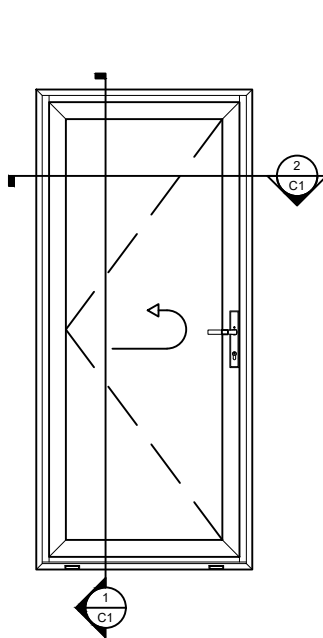

Window Elevation 3/8" = 1' 0"

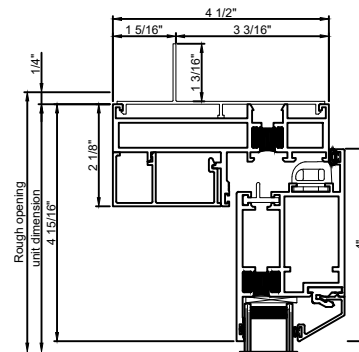

Exterior

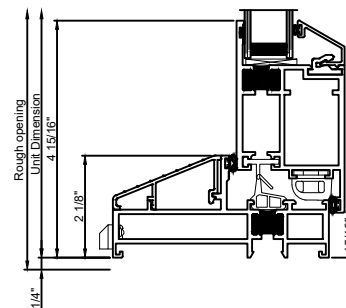

Door cut sections 1 : 4

Note: All dimensions are approximate. Quaker reserves the right to change specifications without notice.



# CityVu-EdgeVu-Bevel (M-Series M605) Inswing Door Sill Options

Cross section details

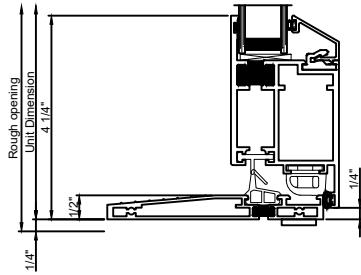

Low Profile Sill

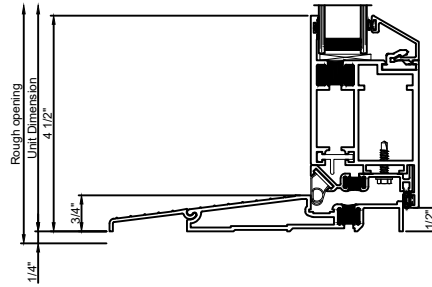

ADA Sill

Door cut sections 1 : 4

Exterior

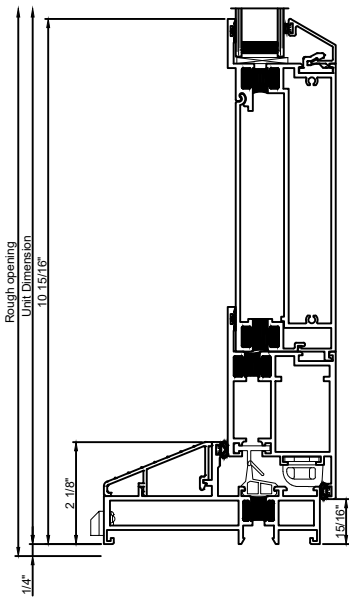

Standard Sill  
10"

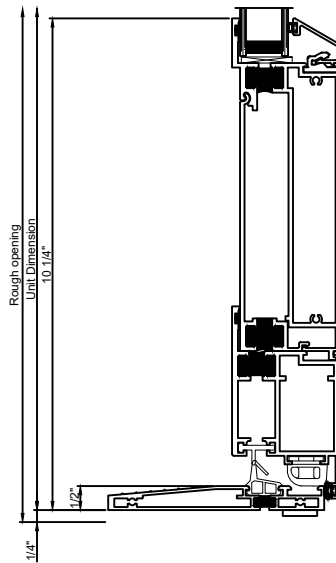

Low Profile Sill  
10"

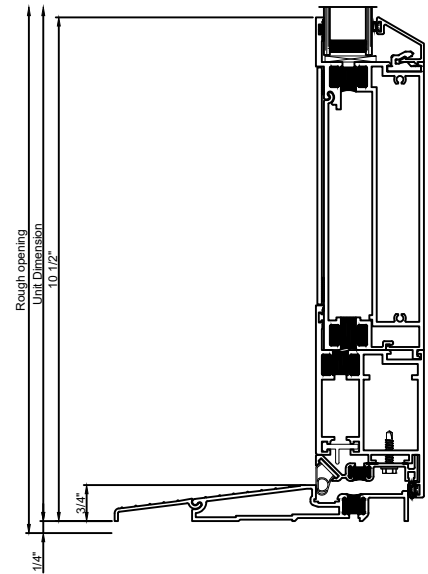

ADA Sill  
10"

Door cut sections 1 : 4

Note: All dimensions are approximate. Quaker reserves the right to change specifications without notice.

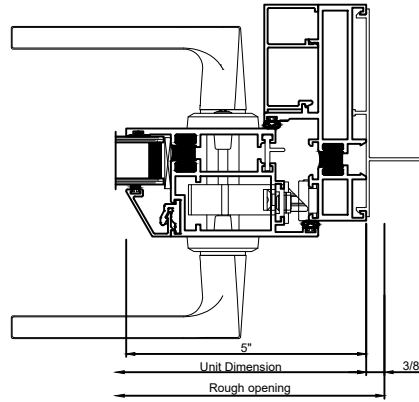
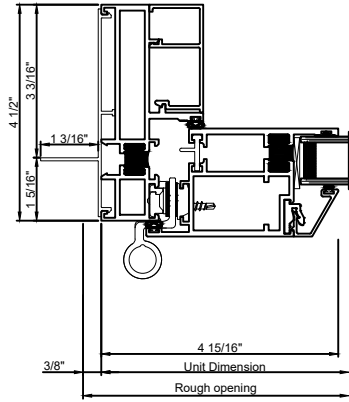

Door cut sections 1 : 4

Exterior

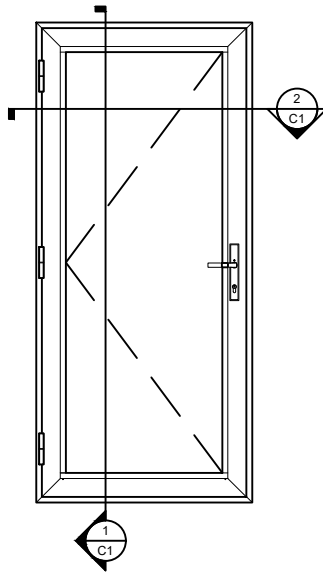

Window Elevation 3/8" = 1' 0"

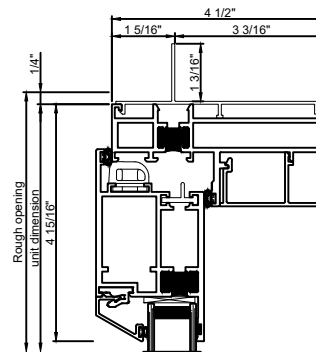

Exterior

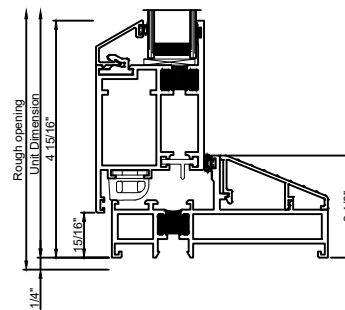

Door cut sections 1 : 4

Note: All dimensions are approximate. Quaker reserves the right to change specifications without notice.



# CityVu-EdgeVu-Bevel (M-Series M605) Outswing Door Sill Options

Cross section details

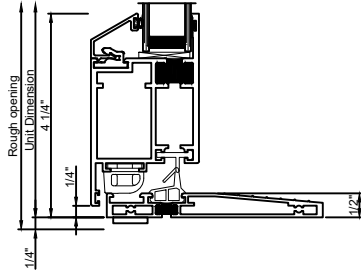

Low Profile Sill

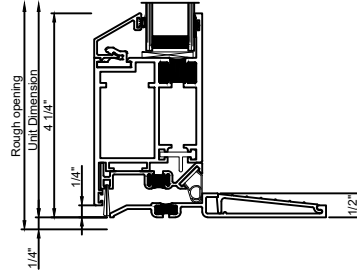

ADA Sill

Door cut sections 1 : 4

Exterior

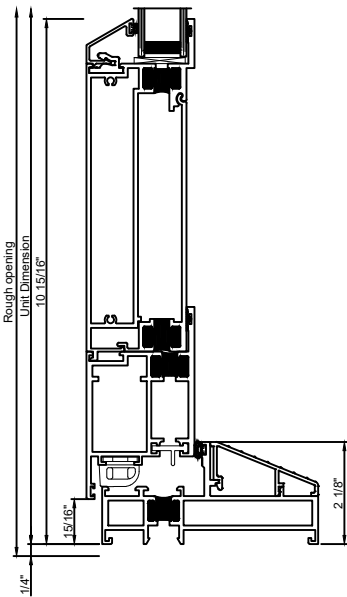

Standard Sill  
10"

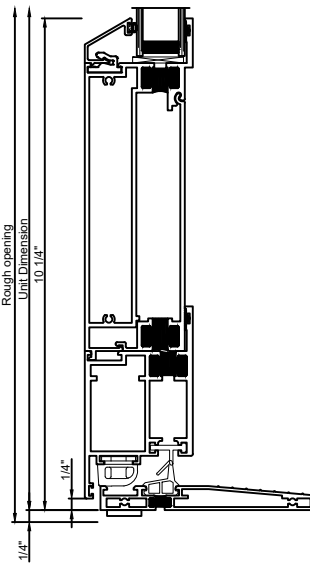

Low Profile Sill  
10"

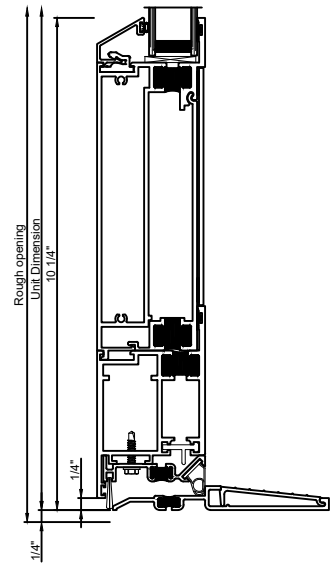

ADA Sill  
10"

Door cut sections 1 : 4

Note: All dimensions are approximate. Quaker reserves the right to change specifications without notice.

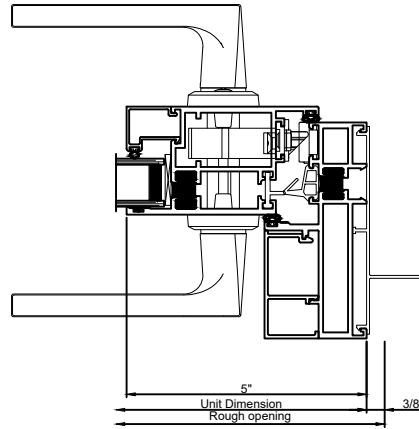
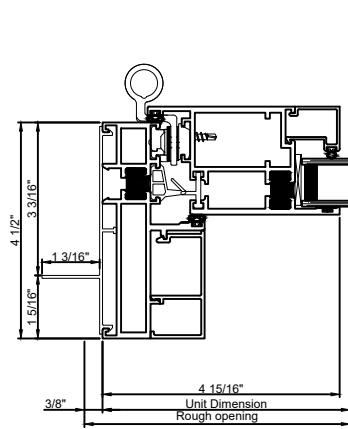

Door cut sections 1 : 4

Exterior

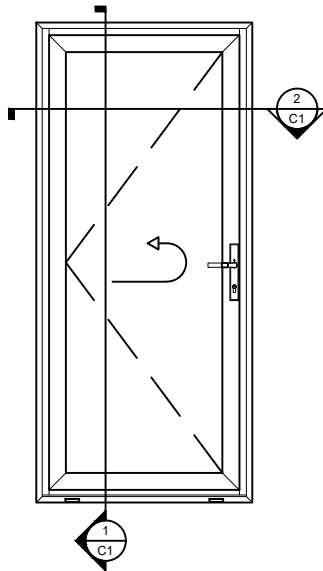

Window Elevation 3/8" = 1' 0"

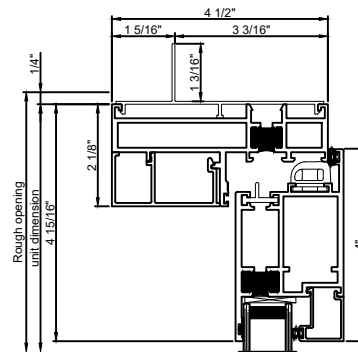

Exterior

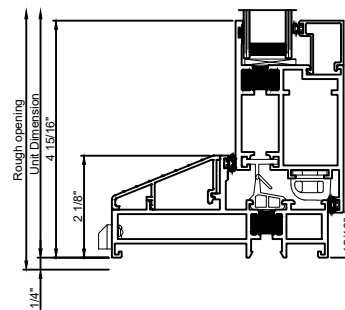

Door cut sections 1 : 4

Note: All dimensions are approximate. Quaker reserves the right to change specifications without notice.

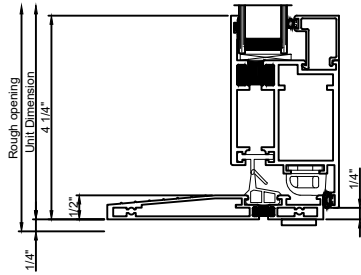

**Low Profile Sill**

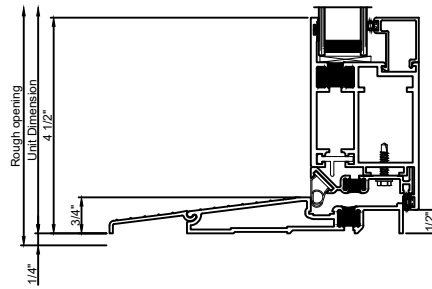

**ADA Sill**

Door cut sections 1 : 4

Exterior

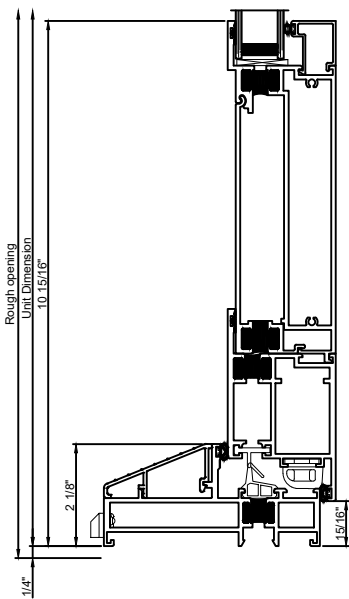

**Standard Sill**  
**10"**

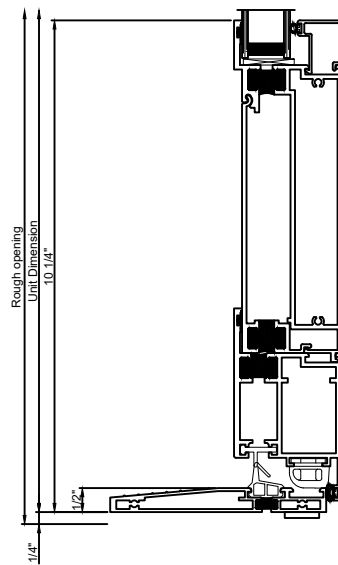

**Low Profile Sill**  
**10"**

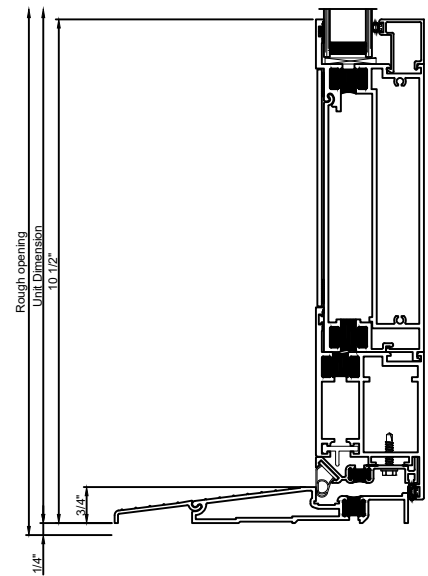

**ADA Sill**  
**10"**

Door cut sections 1 : 4

Note: All dimensions are approximate. Quaker reserves the right to change specifications without notice.

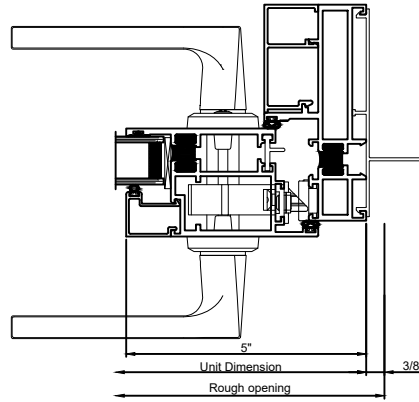
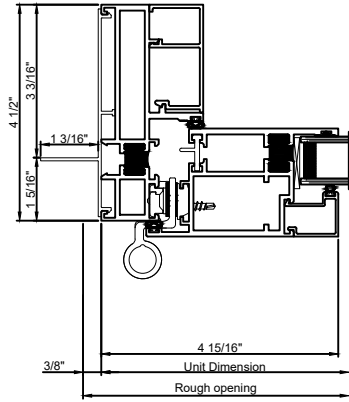

Door cut sections 1 : 4

Exterior

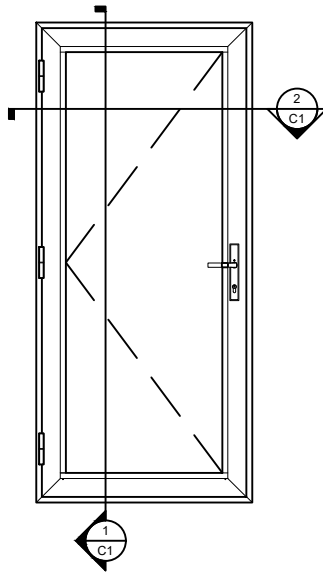

Window Elevation 3/8" = 1' 0"

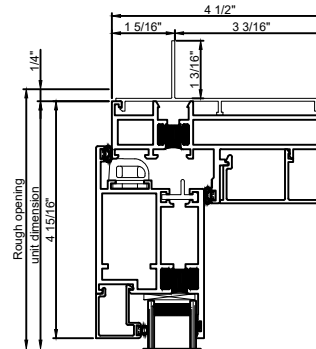

Exterior

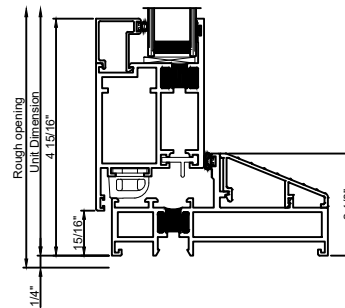

Door cut sections 1 : 4

Note: All dimensions are approximate. Quaker reserves the right to change specifications without notice.



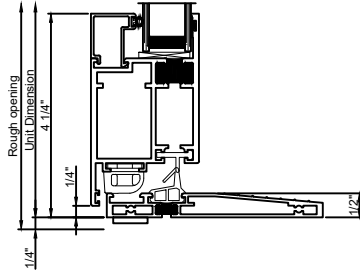

Low Profile Sill

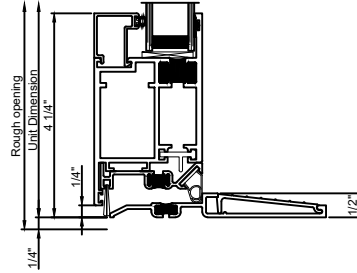

ADA Sill

Door cut sections 1 : 4

Exterior

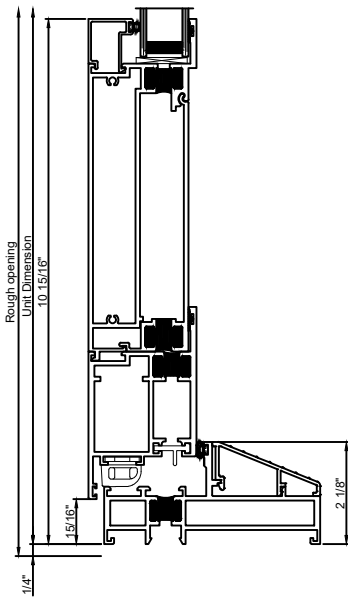

Standard Sill  
10"

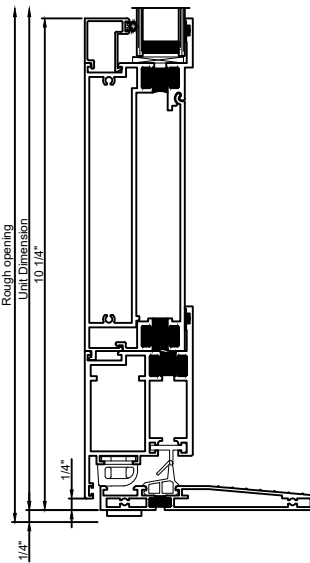

Low Profile Sill  
10"

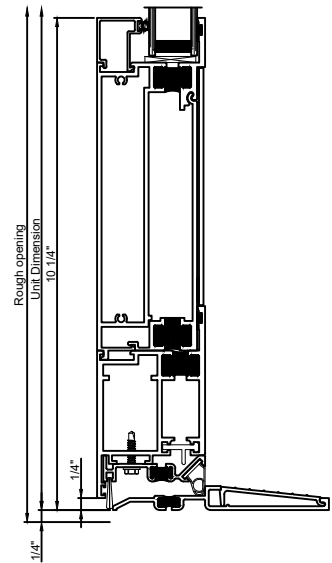

ADA Sill  
10"

Door cut sections 1 : 4

Note: All dimensions are approximate. Quaker reserves the right to change specifications without notice.